



## TABLA DE APLICACIONES POR LÍNEA DE PRODUCTO

REPUESTO FRENO DE DISCO				
NÚMERO DE PARTE REP FD	NÚMERO DE PARTE PISTÓN	MEDIDA DIAMETRO	APLICACIÓN	FOTO PÁGINA
LC-124	832	48.0 mm 1-57/64"	Chevrolet Chevy Joy 94-03. Chevy Swing 94-03, Chevy Monza 97-03. Chevy Pop 94-03. Chevy Vagoneta 00-03. Chevy Pick Up 99-04 Chevy C2 04-10 Delantero.	707
	98728		Volkswagen Golf A-3 CL, GL. 93-99. Golf A-2 C, CL, GL 87-92. Golf A-3 GLS 93-99. Golf Cabrio A-3 96-99. Golf GTI A-2 89-92. Jetta A-2 87-92. Jetta A-3 CL, GL. 93-99. Corsar 85-88, Corsar Variant 86-88. Derby 95-00. Delantero	707
LC-126	96373	54.0 mm 2-1/8"	Volkswagen Combi Panel 73-01.calibrador ATE Delantero	707
LC-127	96363	40.0 mm	Volkswagen Brasilia 74-82, Sedan 95-04.	707
LC-128	98726	44.0 mm	Volkswagen Atlantic 81-87, Caribe 77-87, Caribe GT 83-86, Corsar 83-84, Calibrador Girling. Delantero	707
LC-129	96388	44.0 mm	Volkswagen Atlantic 81-87, Caribe 77-87, Corsar 83-84. Calibrador Ate, Caribe GT 83-86. Delantero	707
LC-435	N/D	32.1 mm 1-17/64"	Renault R-8 66-69 Caliper Trasero	707
LC-436	N/D	38.1 mm 1-1/2"	Renault R-8 66-69 Caliper delantero	707
LC-437	N/D	32.1 mm 1-17/64"	Renault R-8 70-75, R-10 70-75, Caliper Trasero	707
LC-438	N/D	38.1 mm 1-1/2"	Renault R-8, R-10 70-75. Caliper delantero	707
LC-439	4000	48.0 mm 1-57/64"	Renault 12 TL, TS 72-84. Delantero	707
LC-445	4005	45.0 mm	Renault R5 TL 76-85. Delantero	707
LC-446	4018	48.0 mm 1-57/64"	Renault R-18 80-86 Caliper Tipo Bendix. Delantero	707
LC-447	4019	48.0 mm 1-57/64"	Renault R-18 80-84. Caliper Tipo Girling. Delantero	707
LC-640	96540	50.8 mm 2"	Nissan Datsun Sedan 73-84, Sakura 82-84, Estaquitas Pick Up. 72-78. Delantero	707
LC-641	6000	48.0 mm 1-57/64"	Nissan Hikari 88-92. Ninja Turbo 86-87, Sakura 85-86, Samurai 81-87, Tsuru I 84-87, Tsuru II 88-92, Tsuru GS 93-09. Tsubame 93-04, Sentra 1.6 Lts. 92. Delantero Chevrolet Trail Blazer 4X2 LS, LT, 4X4 02-06 Trasero.Chevrolet Trail Blazer 4X4 EXT. 04-06 Trasero	707
LC-642	96542	60.3 mm 2-3/8"	Chevrolet HHR 06-08 Delantero	707
			Nissan Ichi Van 87-94, Estaquitas 72-03. Pick Up D-21 92-03. Pick-Up Doble Cabina 82-00. Pick Up Corto 90-00. Pick -Up King Cab 95-00. Pick-Up Largo 97-03. Pick-Up 250 94-96, Mitsubishi Outlander 04-06, Mitsubishi Eclipse 06-09, Chevrolet Malibu 04-08,	707
LC-643	N/D	54.0 mm 2-1/8"	Nissan Sentra 1.6 Lts 96-00, Lucino GSE 1.6 Lts 96-00 Delantero	708
	85209		Mitsubishi Lancer 04-09, Lancer Ralliart 05-06, Lancer DE ABS, Lancer ES 07-08 Delantero	708
LC-810	76026	78.6 mm 3-3/32"	Dina Camta. 1000 75-77. Delantero	708
LC-815	76028	85.7 mm 3-3/8"	Dina Camta. 3000, 3200 75-77.Delantero	708
LC-1314	85050	78.6 mm 3-3/32"	Chevrolet C-30, 35 79-80. Rodada Sencilla Delantero	708
LC-1449	2902	54.0 mm 2-1/8"	Volkswagen Beetle 1.8, 2.0 98-04 , Golf A3 GTI VR6 95-99. Golf A4 00-03.Golf GTI A4 00-05, Jetta VR6 2.8 Lts A-3 95-99. Jetta A4 00-05. Jetta VR6 96-04. Passat VR6 96-97. Passat y Passat Wagon 96-97, Golf GTI A-3 2.0 L S/ABS 99 , Golf GTI A-4 2.0 L S/ABS 00-05, Beetle Turbo 1.8L 00-05, Polo 03-07, Lupo 05-07, Cross Fox 07-09 Delantero. Seat Alhambra 02-03. Cordoba 01-08. Ibiza 01-08, Toledo 01-03, Seat León 01-05. Delantero	708
	85860		Seat Cordoba 01-08, Ibiza 01-08, Toledo 01-03, Volkswagen Derby 01-04, Golf A4 Cabrio 00-02, Golf A3 GTI 93-98, Golf A3 GTI VR6 95-99, Jetta A3 GLS, Jetta A3 Europa 93-99, Eurovan VR6 2.8 LTS 00-02, Peugeot Partner 04-08 Delantero, Renault Megane 01-03, Megane II 03-07, Megane II Sedan 04-07, Megane II Coupe Convertible 05-07, Megane II Sport 07, Scenic 01-05, Peugeot Partner 04-08, Volkswagen Passat 91-93, Passat Vagoneta 91-92 Delantero	708
	85258		Chevrolet Meriva 04-07 Delantero	708
	85812		Fiat Palio 04-08, Ford Eco Sport 04-07, Fiesta 98-01 y 03-06, Fiesta Sedan 05-06, Fiesta Sedan First, Fiesta Sedan Trend 07-08, Fiesta Ikon 01-05, KA 01-03, KA Sport 04-07, Courier Pick up 01-08 Del. Para autos que llevan la balata 7259-D649	708

**Lusac**

**Raybestos**  
*The best in brakes*
**TABLA DE APLICACIONES POR LÍNEA DE PRODUCTO**

REPUESTO FRENO DE DISCO				
NÚMERO DE PARTE REP FD	NÚMERO DE PARTE PISTÓN	MEDIDA DIAMETRO	APLICACIÓN	FOTO PÁGINA
LC-1458	85218	57.1 mm 2-1/4"	Nissan Almera Comfort 01-05, Altima 96-01 Delantero	708
	N/D		Suzuki Vitara, 06-10, Suzuki SX-4 07-10 Delantero	708
	N/D		Chevrolet Geo Tracker 05-08 Delantero	708
	85393		Honda Accord 4 Cil. 96-02. Delantero	708
	85472		Nissan Altima 96-01, Maxima 91-99, 240 SX 93-98, Infiniti I-30 00-01 Delantero	708
LC-1473	85153	66.7 mm 2-5/8"	Chrysler Jeep Liberty 02-08. Delantero.	708
	85392		Chrysler Jeep Cherokee Sport 94 y 98-01, Jeep Grand Cherokee 93-98, Jeep Wrangler 93-02, Jeep Wrangler Sahara 97-02, Jeep Wrangler Unlimited, Jeep Wrangler Rubicon 03-06, Vam Jeep CJ-5 84-86, Chrysler Town & Country 01-07, Dodge Caravan 01-07 USA Caliper ATE. Delantero.	708
	N/D		Hummer 96-01 USA Delantero.	708
	DPS85200		Vam. Jeep CJ-5 79-86, CJ-7 82-84 Delantero	708
LC-1562	6000	48.0 mm 1-57/64"	Chevrolet Geo Tracker 93-95 y 98-06. Delantero	708
LC-1565	85055	66.7 mm 2-5/8"	Ford Explorer XLS V6, XLT V8, Limited 91-94, Aerostar 91-95, Ford Bronco II 84-90 USA, Ranger 83-94 USA, Mazda Trk.B 94 USA	708
LC-1569	85167	39.7 mm 1-9/16"	Chevrolet Corvette 91-96. Trasero	708
LC-1595	85402	54.0 mm 2-1/8"	Honda Civic EX, SI 97-10. Delantero	708
LC-1668	85177	42.8 mm 1-11/16"	Nissan Pathfinder XE 97-98. Pick Up D-21 92-07. Pick-Up Doble Cabina 97-07. Pick Up Corto 90-00. Pick -Up King Cab 95-00. Pick-Up Largo 97-03. Pick-Up 250 94-96, Estaquitas Pick Up 72-08 Delantero, Nissan Cta. Frontier 4 cil. 00-04 Urvan 00-01 Del Doble	708
LC-1759	N/D	38.1 mm 1-1/2"	Chevrolet Buick Regal 94-96. Cadillac Seville 94-01. Cadillac De Ville 94-99. Cadillac El Dorado 94-97. Trasero. Aztek 01-04. Grand Prix GT, GTP, SE. 97-01, Impala 00-04, Trasero	708
LC-1776	85401	60.3 mm 2-3/8"	Chrysler Sebring R/T 98-00. USA. Delantero	708
LC-1785	N/D	36.0 mm	V.W. Golf GTI A-2 89-92. Trasero	708
LC-1800	85179	42.8 mm 1-11/16"	Nissan D21 92-00. USA. Infiniti Q-45 94-96. Delantero Caliper Doble Piston	708
LC-1837	85438	65.9 mm 2-19/32"	Ford Grand Marquis 95-97. Lincoln Town Car ABS. 95-00. Mustnag GT 98 Delantero	709
LC-1838	76024	73.8 mm 2-29/32"	Ford F-150 86-89 y 92-93, F-200 2A. Versión 86, Caliper de Un Piston. Delantero.	709
	85019		Ford Club Wagon V6 E-150 95-03. Club Wagon V8 E-250 97-04. Econoline Van E-150 95-07, Econoline Wagon E-350 Diesel 01 y 03, Club Wagon V8 E-350 97-98. F-150 94-99. Delantero.	709
LC-1930	85159	42.1 mm 1-21/32"	Chevrolet Buick Regal 94-96. Delantero	709
LC-1962	85163	36.1 mm 1-27/64"	Chrysler Cirrus Sedan 01-05, Concord 01-02, Imperial 91, Intrepid 98-01. Stratus 98-05, 300 M 99-04, Rin 15" y 16", Pt Cruiser 01-08, Pt Cruiser Turbo 03-07, Pt Cruiser Convertible 03-08 Trasero	709
LC-1966	85155	59.5 mm 2-11/32"	Ford Econoline E-350 Van 99 y 06-07. Econoline E-350 Van Diesel 06-07, Club Wagon V8 E-250 95-96, Club Wagon V8 E-250 Chateau 99-00. Econoline Club Wagon V8 E-350 XL 99-06, Econoline Club Wagon V8 E-350 XL 95-96. Trasero F-450 V8 Super Duty 97-02. Del. y Tras. Caliper doble piston Cubrepolvo suave	709
LC-1967	N/D	45.0 mm	Ford Freestar 04-07, Thunderbird 90-96 y 03-04, Cougar 90-95, Cougar XR-7 90-94, Taurus 90-91, Lincoln Mark VIII 94-96 Trasero	709
LC-1973	85158	63.5 mm 2-1/2"	Chevrolet C-15 88-91. C-20, 25 88-91. Delantero	709
LC-2005	85157	74.6 mm 2-15/16"	Chevrolet Avalanche 02-06. Blazer Nevada 92-94. Cadillac De Ville 90-93,97-99, Cadillac Escalade 02-06. Cadillac Escalade Ext 03-06. Silverado 1500 95-01 y 03-06. Silverado 1500 00-01 y 03-06. Silverado 2500 00-01 y 03-06. Silverado 3500 96-06. Sonora 00-06. Suburban 88-00, C-15 94-99, C-20, C-25 y Cheyenne 92-01, G-15 98-05. G-15 Express 1500, Express Cargo Van 1500. 98-06. Express 2500, Express Cargo Van 2500. 99-06. Maxi Cab 91-93. Chrysler Ram 1500 94-00, Ram 2500 94-00, Ram Charger 99, Ram Runner V-10 96-97. Delantero	709



## TABLA DE APLICACIONES POR LÍNEA DE PRODUCTO

REPUESTO FRENO DE DISCO				
NÚMERO DE PARTE REP FD	NÚMERO DE PARTE PISTÓN	MEDIDA DIAMETRO	APLICACIÓN	FOTO PÁGINA
LC-2020	85209	54.0 mm 2-1/8"	Nissan Lucino GSE 96-00, Lucino GSR 2.0 LTS 96-00. Sentra 1.6 LTS. 96-00; Sentra 2.0 LTS. 96-01; Tsuru GSR 2000 Sin ABS. 93-96, Chrysler Verna 04-06. Delantero	709
LC-2024R	85213	40.5 mm 1-19/32"	Nissan 300 ZX 91-96. Delantero	709
LC-2027	N/D	34.0 mm	Nissan Altima 96-01. Infiniti I-30 98-01. Maxima 91-93 y 95-01, 240 SX 93, Honda Civic 06-10, Suzuki SX4 07-10 Trasero	709
LC-2029	85029	57.1 mm 2-1/4"	Chrysler PT Cruiser 01-08, PT Cruiser Turbo Convertible 03-08 Delantero	709
LC-2033	85206	86.1 mm 3-25/64"	Chrysler Ram 3500 94-99. Ram 4000 95-99. Ram Srt-10 05-06. Chevrolet C-30, 35 90 y 92-00. Panel P-30 98-00, C-35, C-3500 HD 96-00, Panel P-30 01-03 Delantero	709
LC-2038	85038	69.8 mm 2-3/4"	Chrysler Dodge Durango 98-02 Delantero.	709
LC-2040	850400	52.0 mm 2-3/64"	Chevrolet Astra 1.8 Lts. 00-03 y 07. Chev. Astra 2.0 Lts. 03-06. Astra 2.2 Lts. Elegance 00-04. Sin ABS Delantero, Astra Turbo 07	709
LC-2043	850390	54.0 mm 2-1/8"	Chrysler Dodge Durango 03-06, Caliper doble piston Delantero	709
LC-2044	DPS85198	34.9 mm 1-3/8"	Chrysler Sebring Coupe 95-00. Trasero USA.	710
LC-2045	850450	48.0 mm 1-57/64"	Chrysler Jeep Grand cherokee 99-02 Delantero. caliper Teves doble piston, Jeep Grand cherokee 99-05 Trasero	710
LC-2048	N/D	34.0 mm	Seat Ibiza 01-08 C/ABS, Seat Cordoba 01-08 S/ABS, Chevrolet Astra 2.2 LTS. Elegance 00-04. Astra 1.8 LTS. HB Confort 00-03, Astra 2.0 LTS. 03-06, sin/ABS, Renault Scenic 01-04 Trasero cubre polvo suave	710
LC-2070	850700	48.0 mm 1-57/64"	Ford Explorer 03-05, Ford Explorer Sport 94-95 y 98-03, Ford Ranger 04-07. Caliper doble piston Delantero.	710
LC-2079	850790	52.0 mm 2-3/64"	Ford Expedition XLT 03-06, Expedition Eddie Bauer 03-06 sin control de vel., Lincoln Navigator 03-06. Trasero	710
LC-2080	N/D	73.0 mm 2-7/8"	Chevrolet Camión Kodiak 96-98 Caliper Doble Piston Delantero y Trasero	710
LC-2081	850810	44.4 mm 1-3/4"	Ford Excursión 2x4 sin/con control de velocidad 01-05 Trasero. Ford Excursión 4x4 sin/con control de velocidad 01-05 Ford F-350 Super Duty 00-04 Trasero. Caliper doble piston	710
LC-2095	N/D	34.0 mm	Chevrolet Astra 2.2 LTS. Elegance 00-04. Astra 1.8 LTS. HB Confort 00-03, Astra 2.0 LTS. 03-06, C/ABS Tras.	710
LC-2103	N/D	38.1 mm 1-1/2"	Volkswagen. Beetle 98-05, Beetle Turbo 00-05, Beetle Cabriolet Turbo 03-05, Golf Cabrio A4 00-02. Golf GTI A-3 93-98. Golf A3 GTI VR6 95-99. Jetta GLS y Europa A-3 93-99. Jetta VR6 A-3 95-99. Passat 91-93. Passat VR6 96-97. Passat 99-05. Eurovan L-5 2.5 LTS. 01-04. Eurovan Vr-6 2.8 LTS. 00-02. Seat Alhambra 02-03. Cordoba 01-08. Ibiza 01-08, Toledo 01-03. Trasero. Chevrolet Astra 1.8 Lts. HB, Comfort. 00-03 Tras. Astra 2.0 Lts. 03-06 Tras. Astra 2.2 Lts. Elegance 00-04, Peugeot 307 03-07 Trasero	710
			Audi A4 97-04 Trasero	710
LC-2105	85196	30.1 mm 1-3/16"	Honda Accord 4 Cil. 96-07, Accord V6 03-07. Trasero	710
LC-2107	851070	57.1 mm 2-1/4"	Chevrolet G-30 03-05, Express 3500 02-06, Express Cargo Van 2500 02-06, Express Cargo Van 3500 02-06 Delantero, Hummer H2 05-08 Delantero, Cadillac DTS 06 Caliper Doble Piston Delantero	710
LC-2110	85156	80.2 mm 3-5/32"	Chevrolet C-30, 35 88-95. G-30 97-02. Express 3500, Express Cargo Van 3500. 97-02. ( 8 Birlos ) Delantero	710
LC-2111	851110	44.4 mm 1-3/4"	Chevrolet Suburban 1500 04-06, Express 2500 Express Cargo van 2500 02-06, Express 3500 Express Cargo van 3500 02-06 Chevrolet Sonora 00-06, Caliper doble piston Trasero	710
LC-2119	85119	45.0 mm	Chevrolet Trail Blazer 02-06 Delantero. Chevrolet Sonora 00-06 Trasero. Chevrolet Avalanche 4x2 02-03 Trasero. Chevrolet Avalanche 4x4 02-04 Trasero. Chevrolet Avalanche 4x4 02-04 Tras. Chevrolet Avalanche 4x4 V8 5.3 Lts. 05-06 Trasero. Cadillac Escalade 2x4 5.3 Lts. 02-06 Trasero Cadillac Escalade 4x4 6.0 Lts. 02-06 Trasero Cadillac Escalade EXT 4x4 03-06 Trasero. Chevrolet Suburban 1500 00-04 Caliper doble piston Delantero Cubre polvo duro	710
LC-2135	85135	64.3 mm 2-17/32"	Honda Odyssey 00-07 Delantero.	710

**Lusac**

**Raybestos**  
*The best in brakes*
**TABLA DE APLICACIONES POR LÍNEA DE PRODUCTO**

REPUESTO FRENO DE DISCO				
NÚMERO DE PARTE REP FD	NÚMERO DE PARTE PISTÓN	MEDIDA DIAMETRO	APLICACIÓN	FOTO PÁGINA
LC-2144	N/D	30.1 mm 1-3/16"	Nissan Sentra 1.6 Lts 96-00, Sentra 1.8 Lts 01-06, Sentra 2.0 Lts 96-01, Tsuru GSR 2000 93-96 Trasero.	710
LC-2148	85148	46.4 mm 1-53/64"	Nissan X Terra 00-05, X Terra S, X Terra SE 06-07 Delantero	711
LC-2152	85152	64.0 mm	Chrysler Grand Voyager 01-06, Town & Country 01-07. Voyager 01-07. Delantero	711
LC-2154	LC850300	55.9 mm 2-13/64"	Chrysler Ram Vam 3500, Ram Wagon 3500 98-02 Ram 4000 00-02 y 05-06, Delantero Caliper Doble Piston.	711
LC-2159	2160	50.8 mm 2"	Chevrolet Silverado 1500 4 X 2 4 X 4 00-01 y 03-06. Silverado 2500 4 X 2 4 X 4 00-01 y 03-06. Silverado 3500 4 X 2, 4 X 4 96-05. Silverado 3500 HD 4 X 2, 4 X 4 96-06. Suburban 00-06, Trasero, Chevrolet Sonora 00-06, Cheyenne 01-06 Delantero. Cal. Doble Piston	711
LC-2183	N/D	40.0 mm	Volkswagen Jetta A4 1.8, 2.0 lts. 00-05, Bora 05-07 Trasero.	711
LC-2215	85215	48.0 mm 1-57/64"	Nissan Platina 02-07, Renault Clio 02-08, Clio Expression 04-08, Clio Energy 07 Delantero	711
LC-2216	85216	44.4 mm 1-3/4"	Nissan Cta. X-trail 01-03 Del. Nissan Cta. Pathfinder Xe 99-04 Del. Nissan Cta. Frontier V6 01-04 Delantero	711
LC-2221	85393	57.1 mm 2-1/4"	Honda Accord V6 98-06. Odyssey 95-99 USA Delantero	711
LC-2225	N/D	38.1 mm 1-1/2"	Ford Thunderbird 03-04, Lincoln LS 00-06, Jaguar X type 02-07, Jaguar S Type 00-07 Delantero caliper doble piston	711
LC-2242	85242	50.8 mm 2"	Ford Freestar 04-06 Delantero	711
LC-2261	85261	57.1 mm 2-1/4"	Cadillac Catera 97-01 Delantero	711
LC-2275	85275	45.0 mm	Chevrolet Camaro, Línea Nueva, Pontiac Firebird, Tran Am 98-02 Caliper doble piston Delantero.	711
	85119		Ford Mustang GT 98-04, Caliper doble piston Delantero.	711
LC-2325	N/D	30.1 mm 1-3/16"	Peugeot 206 00-07. Renault Megane I 01-05, Megane II 04-07, Trasero	711
LC-2390	85390	48.0 mm 1-57/64"	Chevrolet Corsa Sedan 03-07. Corsa 02-07, Tornado 04-07. Delantero	711
LC-2394	853940	60.3 mm 2-3/8"	Chevrolet Malibu LX 97-01. Malibu LS V6 97-05. Pontiac Grand Am 99-05 Delantero	711
LC-2470	85470	60.0 mm	Chrysler Stratus 98-06, Cirrus 01-07 Delantero	711
LC-2472	85391	57.1 mm 2-1/4"	Chevrolet Astra 1.8 Lts. 00-03 Sin ABS. Chev. Astra 2.0 Lts. 03-06. Astra 2.2 Lts. Elegance 00-04. Con ABS, Sentra Vagoneta 1.8 Lts 01-03, Zafira 02-06,	712
	85472		Nissan Sentra XE, Sentra GXE 01-09, Nissan Sentra 07-09 Delantero	712
	N/D		Ford Fusión 06-08, Nissan Sentra 08-09 Delantero	712
LC-2473	107534	54.0 mm 2-1/8"	Chrysler Durango 03-06. Ram 1500 03-08. Ram Van 1500 02-03. Ram Wagon 1500 02-03. Ram 2500 03-04, Aspen 07-08. Trasero	712
LC-2475	85475	46.0 mm 1-13/16"	Chevrolet Blazer 98-01, Trail Blazer 4 X 2 LS, LT. 02-05, Trail Blazer 02-06, doble piston delantero	712
	N/D		Chevrolet Sonora 00-06, Chevrolet Avalanche 4x2 02-03, Chevrolet Avalanche 4x4 02-04, Chevrolet Avalanche 4x4 V8 5.3 Lts. 05-06, Cadillac Escalade 2x4 5.3 Lts. 02-06, Cadillac Escalade 4x4 6.0 Lts. 02-06, Cadillac Escalade EXT 4x4 03-06 Trasero caliper doble piston,	712
LC-2476	85476	38.1 mm 1-1/2"	Chevrolet Venture APV 98-04. Pontiac Montana SV6 05-07, Torrent 06 Tras. Pontiac Aztek 01-05 4x4. Tras Chevrolet Impala C/S/ ABS 00-04 Tras Grand Prix GT, GTp, Se. 97-01, Toyota Camry 02-06, Toyota Solara 05-07, Mitsubishi Outlander 04-06 4 cil. 2.4L, Honda Pilot 03-08 Trasero Cubre polvo Suave	712
LC-2477	85456	48.0 mm 1-57/64"	Jeep Liberty 03-08 Tras, Jeep Wrangler, Jeep Wrangler Sahara, Jeep Wrangler Rubicon 03-06 Jeep Gran Cherokee 95-98 Trasero	712
	N/D		Ford Lincoln Aviator 03-05, Lincoln Town Car 98-02, Explorer 95-97, Explorer Eddie Bauer 98-09, Explorer Sport 94-03 Trasero	712
	85491		Ford Explorer XLS V6, XLT V8, Limited s/cont/vel 95-10 Tras. Explorer Sport s/c de tracc. y c/c de tracc. 4x2 94-95 y 98-03, Mercury Mountaineer 05 Trasero	712
LC-2478	96542	60.3 mm 2-3/8"	Nissan Pick Up D-21 92-00. Delantero. Americana Caliper de 1 Pistón USA.	712



## TABLA DE APLICACIONES POR LÍNEA DE PRODUCTO

REPUESTO FRENO DE DISCO				
NÚMERO DE PARTE REP FD	NÚMERO DE PARTE PISTÓN	MEDIDA DIAMETRO	APLICACIÓN	FOTO PÁGINA
LC-2479	854790	65.9 mm 2-19/32"	Chevrolet Truck C-30, C-35, C-36, 3500 Heavy Duty 01-02 Delantero y Trasero Caliper doble piston	712
LC-2484	85484	60.3 mm 2-3/8"	Chevrolet Luv 97-05 Delantero	712
LC-2486	85486	47.6 mm 1-7/8"	Nissan Quest S, Quest SE, Quest SL 04-09, Urvan Carga 00-05 Caliper Doble piston Delantero	712
LC-2489	85489	45.0 mm	Chrysler Ram-1500 03-08, Ram-2500, Ram-2500 Quad Cab 01-06, Ram-2500 ST, Ram-2500 Quad Cab SLT 07-08, Ram-2500 Quad Cab SLT Diesel 03-07, Ram-2500 Mega Cab Laramie 06-08, Ram 4000 05-08 Trasero	712
LC-2492	85492	44.0 mm	Ford Windstar GL, LX s/c.de tracc. y c/c de tracc. 95-98 Tras. Windstar LX, SE, SE Limited s/c.de tracc. y c/c de tracc. 99-03 Trasero	712
LC-2493	85493	38.1 mm 1-1/2"	Pontiac Gran Am 99-05 Trasero. Cubrepolvo Duro	712
LC-2496	85496	48.0 mm 1-57/64"	Pontiac Matiz 04-05 Delantero	712
LC-2500	85860	54.0 mm 2-1/8"	Peugeot 206 00-08, 206 XR 00-07, 206 XT 03-07, 307 03-07, Renault Megane II 05-07, Kangoo Pasajeros 07, Kangoo Express 04-07, Renault Trafic Carga, Trafic 9 Pasajeros 07 Delantero	712
LC-2725	2724	50.8 mm 2"	Chrysler Atos 01-07. Delantero	712
LC-2730	99980	55.6 mm 2-3/16"	Ford F-250 92-94. F-350 93-94. P-35 Microbus 89-95. Delantero	712
LC-2735	DPS85840	30.1 mm 1-3/16"	Ford Escort 94-01. Escort LX 94-01. Escort Vagoneta 97-99. Escort GT 94-95. Trasero	713
LC-2746	85167	39.7 mm 1-9/16"	Chevrolet Camaro 95-97. Firebird, Trans Am 94-97. Trasero	713
LC-2769	85424	47.6 mm 1-7/8"	Ford Grand Marquis 92-04. Lincoln Town Car 91-00. Trasero	713
LC-2776	85384	54.0 mm 2-1/8"	Ford Escort 94-01. Escort LX 94-01, Escort Vagoneta 94-99. Escort GT 94-95. Delantero	713
LC-2783	85425	38.1 mm 1-1/2"	Nissan Infiniti Q45 94-96. Trasero	713
LC-2797	DPS85169	54.0 mm 2-1/8"	Ford Lincoln Continental 97-99, Sable 94-04, Sable Vagoneta 94-97, Trasero	713
LC-2801	85860	54.0 mm 2-1/8"	Seat Alhambra 02-03, Volkswagen Passat 99-05 Deantero	713
LC-2810	85810	54.0 mm 2-1/8"	Ford Focus LX, SE, ZTS, Wagon 00-06. Focus ZX3 00-04, Focus SVT 02. Ford Expedition XLT, Eddie Bauer sin y con/ctrol de velocidad 03-06 Del.. Lincoln Navigator 03-05 Delantero. Caliper Doble Piston. Volkswagen Bora 06-07 Delantero,	713
LC-2813	85813	48.0 mm 1-57/64"	Ford Fiesta 98-06, Fiesta Ikon 01 Delantero para autos que llevan la balata C0175, Mini Cooper 02-06 Delantero	713
LC-2814	85814	48.0 mm 1-57/64"	Ford Windstar 99-03. Caliper Doble piston Delantero	713
LC-2815	85815	54.0 mm 2-1/8"	Ford Excursion 4X2 y 4X4 01-05. F- 250, F-250 y Super Duty 99-04. F-350 Super Duty 99-04. Doble piston Delantero	713
LC-2817	85477	48.0 mm 1-57/64"	Ford Grand Marquis 98-04. Lincoln Town Car 98-07 Caliper doble piston Delantero.	713
	N/D		Ford Lobo 97-04 Delantero.	713
	85817		Ford F-150 97 - 04. Delantero	713
LC-2820	85393	57.1 mm 2-1/4"	Ford Mondeo Core 01-04. Mondeo Trend 01-04. Mondeo Ghia 01-04. Delantero	713
LC-2823	N/D	38.1 mm 1-1/2"	Ford Mustang GT 94-04, Cobra 97 Trasero	713
LC-2826	85826	50.8 mm 2"	Ford Expedition XLT 97-02, Expedition Eddie Bauer 97-02, F- 250, F-250 Super Duty 98-02. Lincoln Navigator 98-02. Doble piston Delantero	713
LC-2827	85013	50.8 mm 2"	Ford F-150 97-99, Ford Lobo 150 Y 250 99-04 s/c vel, Ford F-250 Sup. Duty 4x4 03-04, Ford Lincoln Blackwood 03 Caliper Doble Piston Delantero.	713
	85827		Ford Expedition 97-02, F-150 97-04, F-250 97-02, Ford F-250 Sup. Duty 4x4 03-04, Ford Lobo 150 Y 250 97-04, Lincoln Town Car 03-06, Navigator 98-02 Caliper sencillo trasero	713
LC-2844	85800	60.0 mm	Ford Contour 96-00, Escape 01-06. Mystique 95-00, Mercury Mariner 05-08 Delantero	714

**Lusac**

**Raybestos**  
*The best in brakes*
**TABLA DE APLICACIONES POR LÍNEA DE PRODUCTO**

REPUESTO FRENO DE DISCO				
NÚMERO DE PARTE REP FD	NÚMERO DE PARTE PISTÓN	MEDIDA DIAMETRO	APLICACIÓN	FOTO PÁGINA
LC-2845	85469	54.0 mm 2-1/8"	Chrysler Breeze 96. Cirrus 96- 00. Cirrus Coupe 99-00. Cirrus Convertible 01-05. Sebring 97. Stratus 95-97, Stratus R-14 95-00, Stratus R-15 96-97. Delantero	714
LC-2857	85857	46.0 mm 1-13/16"	Ford Explorer XLS V6, XLT V8, Limited. 95-02. Ranger 96-07, Chevrolet Equinox 05-07. Doble piston Delantero	714
LC-2885	850300	55.9 mm 2-13/64"	Ford Club Wagon V8 E-250 95-96. Club Wagon V8 E-250 Chateau 95-96 y 98-00. Econoline Club Wagon V8 E-350 XL 99-06, Econoline Club Wagon V8 E-350 XL 95-96. Econoline Van E-250 97-99. Econoline Van E-350 98-99 y 06-07. Econoline Van E-350 Diesel 06-07, F-350 95-04. F-250 95-97, P-350 Microbus 94-97. Caliper doble piston Delantero	714
LC-2901	2900	48.0 mm 1-57/64"	V.W. Pointer 98-02. Pointer City 00-02. Pointer Vagoneta 99-02, Pointer Pick Up 99-07 Delantero	714
LC-20020	850020	42.0 mm	Chrysler Voyager 01-07 Tras.	714
LC-20460	850460	47.6 mm 1-7/8"	Chrysler Jeep Grand cherokee 99-05, Caliper Akebono doble piston Delantero	714
LC-20930	85471	59.5 mm 2-11/32"	Ford F-450 V10 Super Duty 99-06, F-450 V8 Diesel Super Duty 05-06, F-550 V10 Super Duty 01-06. Del y Tras caliper doble piston Cubrepolvo duro	714
LC-21003	N/D	65.9 mm 2-19/32"	Chevrolet Optra 06-09 Trasero.	714
LC-21004	N/D	57.1 mm 2-1/4"	Chevrolet Vectra 4 Cil. 03-08 Delantero.	714
LC-21005	N/D	34.0 mm 1 11/32"	Ford Fusion 06-09 Trasero	714
LC-21010	851010	50.8 mm 2"	Chevrolet Express 8 birlos 03-08 Trasero	714
LC-21013	85013	54.0 mm 2-1/8"	Chevrolet Pontiac G5, G6 05-07 delantero	714
LC-21014	851014	54.0 mm 2-1/8"	Toyota Yaris 07-09 Delantero	714
LC-21015	851015	57.1mm 2-1/4"	Mazda 3 06-08 Del., Volkswagen Sharan 02-07 Delantero	714
LC-21016	851016	57.15mm 2-1/4"	Isuzu ELF 450 4 Cilindros Diesel 06-09 Delantero	714
LC-21019	N/D	65.9 mm 2-19/32"	Toyota Rav 4 Del. 06-10 Delantero	715
LC-21020	6000	48.0 mm 1-57/64"	Chevrolet Blazer 98-01 trasero. Sello grueso para caliper Delphi, sello delgado para caliper GM	715
LC-21023	N/D	60.3 mm 2-3/8"	Ford F-450 Superr Duty XL, XLT, Super Duty KTP 06-10 Caliper doble piston Delantero	715
LC-21041	N/D	63.5 mm 2-1/2"	Mitsubishi Endeavor 04-08 Delantero	715
LC-21042	851042	60.0 mm	Hyundai H-100 Gasolina 03-06 Delantero	715
LC-21047	851047	60.0 mm	Chevrolet Vectra 03-08 delantero	715
LC-21051	853220	63.5 mm 2-1/2"	Toyota Sienna CE Sienna LE Sienna XLE 04-07 Del.	715
LC-21052	851052	45.5 mm	Chevrolet Colorado 04-08 Delantero	715
LC-21067	851067	54.0 mm 2-1/8"	Chrysler Attitude GL, GLS 06-10, Volkswagen Pointer Vagoneta 99-00 Delantero	715
LC-21068	85209	54.0 mm 2-1/8"	Chevrolet Optra 06-08 Delantero	715
LC-21069	N/D	38.1 mm 1-1/2"	Chevrolet Malibu 04-07 Trasero	715
LC-21072	853220	63.5 mm 2-1/2"	Honda Pilot 03-08 Delantero	715
LC-21075	851075	66.7 mm 2-5/8"	Toyota Hiace, carga, largo, corto y pasajeros 06-07 Delantero.	715
LC-21076	851076	42.8 mm 1-11/16"	Toyota Hilux 04-08 Delantero	715
LC-21080	85392	66.0 mm	Chrysler Town & Country 01-07, Caravan 01-07 Delelantero	715
LC-21160	85152	64.0 mm	Pontiac Aztek 01-05 Delantero	715
LC-21310	N/D	33.7mm	Honda Accord V6 98-02 Trasero	716
LC-21330	851330	57.1 mm 2-1/4"	Honda CR-V 02-06, Toyota Corolla 03-06, Toyota Matrix 03-07 Delantero	716
LC-21341	851340	38.1 mm 1-1/2"	Honda CR-V 02-06 Trasero	716
LC-21470	851470	34.9 mm 1-3/8"	Nissan Cta. X-trail 01-07, Altima 02-07 Trasero	716
LC-21640	N/D	38.1 mm 1-1/2"	Nissan Almera 01-05 Trasero	716
LC-21995	N/D	54.0 mm 2-1/8"	Chevrolet Vectra 03-08, Ford Focus SVT 02-03 Trasero	716



## TABLA DE APLICACIONES POR LÍNEA DE PRODUCTO

REPUESTO FRENO DE DISCO				
NÚMERO DE PARTE REP FD	NÚMERO DE PARTE PISTÓN	MEDIDA DIAMETRO	APLICACIÓN	FOTO PÁGINA
LC-23220	853220	63.5 mm 2-1/2"	Toyota Camry 02-08, Toyota Sienna 04-07, Toyota Rav 4 06-10 Delantero.	716
LC-23260	853260	50.8 mm 2"	Toyota Yaris 04-07 Delantero	716
LC-23270	853940	60.3 mm 2-3/8"	Toyora Rav4 04-07 Delantero	716
LC-59162	N/D	50.8 mm 2"	VAM Javelin 70. Delantero	716
LC-59171	76014	41.3 mm 1-5/8"	Chrysler Dodge Dart 70-73, Valiant Duster 70-73. Delantero	716
LC-59176	76008	74.6 mm 2-15/16"	Chevrolet Blazer Nevada 91. Caprice 78-82, Chevelle 70-75, Chevelle Malibu 70-75, Chevy Nova 73-78, Impala 70-75, C-10 71-78, C-15 82-87, C-20, 25 79-87. C-30, 35 71-78. G-20 95. Suburban 87-88. VAM Wagonner 77-86. Wagoner J-164 74-76. Dina 1000 77-83, Dina 3000, 3200 77-83. Delantero	716
LC-59177	76018	69.8 mm 2-3/4"	Chrysler Cordoba 80-82, Dart 76-82, Valiant Duster 76, Le Baron 78-82. Magnum 81-82, Monaco 70-73. D-100 72-73. D-300 72-78. Valiant Volare 77-81, Ford Galaxie 70-74. Delantero.	716
	DPS85016		Chrysler Coronet 71-74, Super Bee 70-80, VAM American 74-76, Rally 71-75. Delantero.	716
	N/D		Vam. Classic 74-75, Gremlin 76-83 Caliper Kh, Javelin 71-73. Delantero	716
LC-59178	DPS-85001	60.3 mm 2-3/8"	Ford Mustang 71-73. Delantero	716
LC-76090	76024	73.0 mm 2-7/8"	Ford F- 100 73-79, F-150 84-85 y 90-91, P-350 Microbus 77-78. Caliper de Un Piston. Delantero	716
LC-76092	76021	79.4 mm 3-1/8"	VAM Classic 76, Gremlin 74-83. Con Caliper Bendix, Pacer 76-79, Rally 73-75. Jeep CJ-5 78. Caliper Bendix. Delantero	716
LC-76390	76021	79.4 mm 3-1/8"	Ford Ltd 75-78 Delantero.	717
	76026		Chrysler M-300 80. Delantero	717
LC-80926	76021	79.4 mm 3-1/8"	Chrysler Dodge Monaco Polare 1974-77. D100, 73-80, D300 1973-77. Delantero USA	717
LC-83297	76028	85.7 mm 3-3/8"	Chevrolet C-30, 35 71-89 y 96-00, Microbus 88-00, Panel 30 82-98. Delantero (C-30, C35 96-00 Trasero)	717
LC-83691	76025	65.9 mm 2-19/32"	Ford F - 150 80-83. Delantero.	717
	76027		Chrysler Dart 73-76, Valiant Duster 73-76, Ford Maverick 74-77. Mustang 74-78, VAM American 77-83, Classic 76 Sin Boster, Rally 76-83, Jeep CJ-5 78. Delantero.	717
	85438		Ford Lincoln Continental 97-99, Lincoln Mark VIII 94-96, Sable 94-04. Sable Vagoneta 94-97. Windstar GL, LX 95-98. Delantero.	717
LC-88562S	99980	55.6 mm 2-3/16"	Ford F350 76-83. Delantero	717
LC-88562D	99980	55.6 mm 2-3/16"	Ford F-200 86-91, F-350 73-92, P-350 76-78 y 89-91. Delantero Caliper doble piston	717
LC-98948	98899	73.0 mm 2-7/8"	Ford Crown Victoria 81, Gran Marquis 82-84 y 92-94, Lincon Town Car 91-94, Ford Ltd 79-80. Delantero	717
LC-99024	85088	63.5 mm 2-1/2"	Chevrolet Cadillac Seville 97-04 y 03-04. Cadillac DeVille 97-04, Grand Prix GT, GTP, Se. 97-01, Impala 00-04, Venture APV 97-04, Pontiac Torrent 06, Venture APV 97-04 Delantero (Acero)	717
	85388		Chevrolet Oldsmobile 88 92 y 94-95, Silhouette 92 y 94-95, Camaro 95-97, Grand Prix, GT, GTP, SE 97-01, Impala 00-04, Venture APV 97-04 Delantero (Acero)	717
	76033		Chevrolet Silhouette 92 y 94-95, Chevrolet Blazer 95-97, Chevelle Malibu 79-81. Monte. Carlo 81-84, Century 83-96, Cutlass 90-96, Cutlas Eurosport 90-96, Silhouette 91. S-10 Pick Up 95-04.	717
	N/D		Chevrolet Uplander 05-09, Pontiac Montana 05-07 Delantero	717
LC-99079	99080	60.0 mm	Ford Cougar 85-88, 93-95. Cougar XR-7 90-94, Fairmont 78-83, Mustang 79-84, Thunderbird 85-88 y 93-96. Cubre Polvo Blando. Delantero	717
LC-100797	85389	57.1 mm 2-1/4"	Chevrolet Cavalier 92-04, Cavalier Z-24 92-96, Sunfire 97-02 y 04-05. Delantero.	717
	100799		Chevrolet Cavalier 90-91. Cavalier Z-24 91. Celebrity 82-89, Citation 82-86, Cutlass 87-89, Cutlass Eurosport 87-89. Delantero.	717



## TABLA DE APLICACIONES POR LÍNEA DE PRODUCTO

REPUESTO FRENO DE DISCO				
NÚMERO DE PARTE REP FD	NÚMERO DE PARTE PISTÓN	MEDIDA DIAMETRO	APLICACIÓN	FOTO PÁGINA
LC-101491	76021	79.4 mm 3-1/8"	Chrysler Monaco 74-77. D-100 73-80. D-150 81-93. D-250 86-93. D-300 72-80, D-350 81-93. Microbus 81-93. M-300 78. W-150 85-87. W-250 4X4 86-93. Delantero.	717
	76026		Chrysler M-300 78. Ram Charger 86-96. Ram Van 1500 95-97. Ram Wagon 1500 95-97. Ram Van 2500 96-97. Ram Wagon 2500 96-97. Ram Van 3500 96-97. Ram Wagon 3500 96-97. Delantero.	717
LC-102443	2904	54.0 mm 2-1/8"	V.W. Pointer 98-04. Pointer City 00-04. Pointer MI 2.0 Lts. 03-04, Pointer GTI 00-02, Pointer Vagoneta 99-04. Delantero.	717
	107534		Chrysler Dart "K" y Guayin 82-88, Dart "E" 89, Le Baron "K" 83-87, Magnum "K" 83-88, Neon 95-05. New Yorker 85-89, Phantom 87-89, Serie 600 "K" 84-85, Shadow 89-94, Shadow GTS Turbo 89, Spirit 90-95, Volare "K" 82-88, Delantero caliper sencillo, Ram Van 1500 98-03, Ram Wagon 1500 98-03, Ram 1500 01-08, Ram 2500 01-04, Ram Van 2500 98-02, . . Ram Wagon 2500 98-02, Ram Charger 00-01. Delantero Caliper Doble piston .	717
LC-103299	76018	69.8 mm 2-3/4"	Chrysler Cordoba 82, Valiant Duster 76, Valiant Volare 80-81, Le Baron 81-82 Delantero.	717
LC-108241	85076	60.0 mm	Chrysler Grand Voyager 84-93 Rin 14" USA. Delantero (Acero).	717
	108159		Chrysler Concorde 93-97 Y 01-02, Imperial 91, Intrepid 94-01, Le Baron 92-95, New Yorker 90-94, New Yorker LH, LHS 94-97, Phantom 90-94, Spirit R/T 91-95, 300 M 99-04, Grand Voyager 91-00, Town & Country 93-00, Voyager 94-00, Ford Ghia 91-94, Topaz 84-94, Nissan Quest Xe 97-02. Delantero.	717
LC-112486	85171	65.9 mm 2-19/32"	Ford Cougar 90-92. Thunderbird 89-92, Delantero (Acero).	717
	115614		Ford Taurus 88-91, Delantero.	717
	N/D		Ford Mustang GT 94-97 Delantero.	717
LC-118265	119043	34.1 mm 1-11/32"	Chrysler Cirrus 96-05., Cirrus Coupe 99-00., Cirrus Convertible 01-05, Concorde 93-97, Intrepid 94-97, Le Baron 92-95, Neon 95-05, New Yorker 90-97, LHS 94-97, Phantom 90-94, Sebring R/T 97, Shadow GTS y turbo 89, Spirit R/T 91-95, Stratus 96-06, Trasero	717



- Hules especialmente diseñados para resistir las altas temperaturas generadas en el sistema de frenos
  - Excelente acabado para un funcionamiento óptimo
- Sometidas a una prueba de calentamiento en horno durante 22 horas continuas para garantizar la flexibilidad del material
- Nuestros sellos de alta presión (ligas) cuentan con la configuración correcta que evita fugas y ayuda en el retroceso del pistón
  - Amplia cobertura para todas las marcas



**Lusac**



**Raybestos**  
The best in brakes

FOTOS REPUESTOS FRENO DE DISCO

## REPUESTOS FRENO DE DISCO

## LC-124 - LC-642

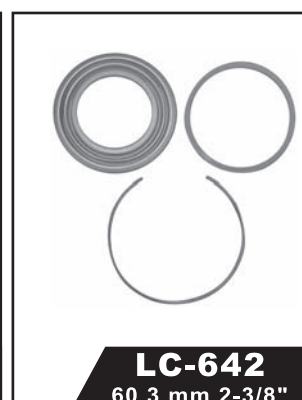
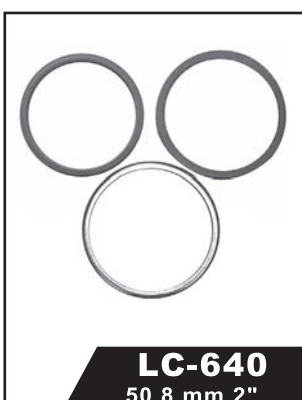
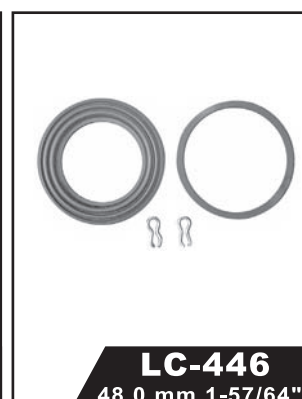
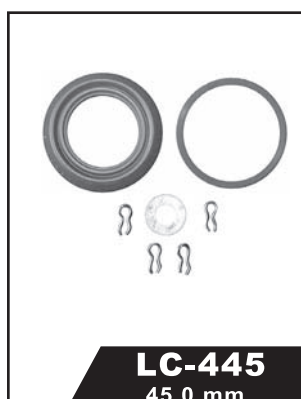
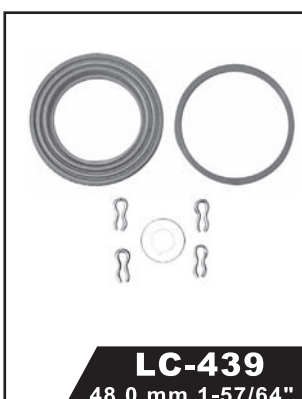



**Lusac**



**Raybestos**  
The best in brakes

**REPUESTOS FRENO DE DISCO**

**LC-643 - LC-1800**

<p><b>LC-643</b> 54.0 mm 2-1/8"</p>	<p><b>LC-810</b> 78.6 mm 3-3/32"</p>	<p><b>LC-815</b> 85.7 mm 3-3/8"</p>	<p><b>LC-1314</b> 80.2 mm 3-5/32"</p>
<p><b>LC-1449</b> 54.0 mm 2-1/8"</p>	<p><b>LC-1458</b> 57.1 mm 2-1/4"</p>	<p><b>LC-1473</b> 66.0 mm</p>	<p><b>LC-1562</b> 48.0 mm 1-57/64"</p>
<p><b>LC-1565</b> 66.7 mm 2-5/8"</p>	<p><b>LC-1569</b> 39.7 mm 1-9/16"</p>	<p><b>LC-1595</b> 54.0 mm 2-1/8"</p>	<p><b>LC-1668</b> 42.8 mm 1-11/16"</p>
<p><b>LC-1759</b> 38.1 mm 1-1/2"</p>	<p><b>LC-1776</b> 60.3 mm 2-3/8"</p>	<p><b>LC-1785</b> 36.0 mm</p>	<p><b>LC-1800</b> 42.8 mm 1-11/16"</p>



**Lusac**



**Raybestos**  
The best in brakes

FOTOS REPUESTOS FRENO DE DISCO

## REPUESTOS FRENO DE DISCO

## LC-1837 - LC-2043

<p><b>LC-1837</b> 65.9 mm 2-19/32"</p>	<p><b>LC-1838</b> 73.0 mm 2-7/8"</p>	<p><b>LC-1930</b> 42.06 mm 1-21/32"</p>	<p><b>LC-1962</b> 36.1 mm 1-27/64"</p>
<p><b>LC-1966</b> 59.5 mm 2-11/32"</p>	<p><b>LC-1967</b> 45.0 mm</p>	<p><b>LC-1973</b> 63.5 mm 2-1/2"</p>	<p><b>LC-2005</b> 74.6 mm 2-15/16"</p>
<p><b>LC-2020</b> 54.0 mm 2-1/8"</p>	<p><b>LC-2024R</b> 40.5 mm 1-19/32"</p>	<p><b>LC-2027</b> 34.1 mm 1-11/32"</p>	<p><b>LC-2029</b> 57.1 mm 2-1/4"</p>
<p><b>LC-2033</b> 86.1 mm 3-25/64"</p>	<p><b>LC-2038</b> 69.8 mm 2-3/4"</p>	<p><b>LC-2040</b> 52.0 mm 2-3/64"</p>	<p><b>LC-2043</b> 54.0 mm 2-1/8"</p>



**Lusac**



**Raybestos**  
The best in brakes

**REPUESTOS FRENO DE DISCO**

**LC-2044 - LC-2144**

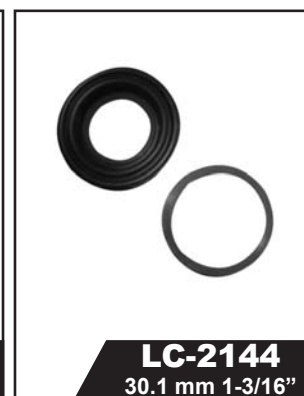
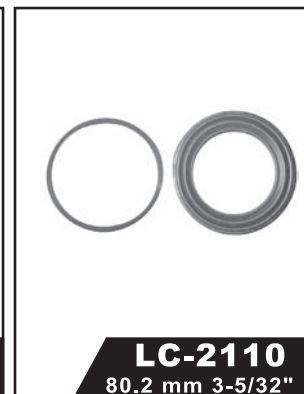
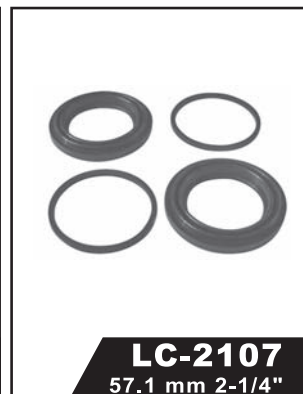
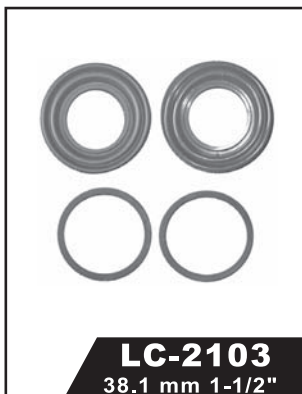
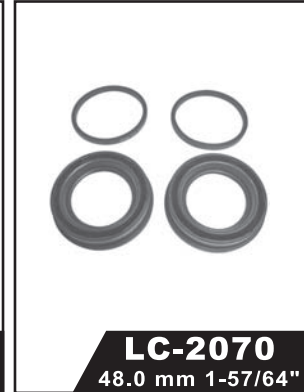



**Lusac**



















**Raybestos**  
The best in brakes

FOTOS REPUESTOS FRENO DE DISCO

## REPUESTOS FRENO DE DISCO

## LC-2148 - LC-2470

 <p><b>LC-2148</b> 46.4 mm 1-53/64"</p>	 <p><b>LC-2152</b> 64.0 mm</p>	 <p><b>LC-2154</b> 55.9 mm 2-13/64"</p>	 <p><b>LC-2159</b> 50.8 mm 2"</p>
 <p><b>LC-2183</b> 40.0 mm</p>	 <p><b>LC-2215</b> 48.0 mm 1-57/64"</p>	 <p><b>LC-2216</b> 44.4 mm 1-3/4"</p>	 <p><b>LC-2221</b> 57.1 mm 2-1/4"</p>
 <p><b>LC-2225</b> 38.1 mm 1-1/2"</p>	 <p><b>LC-2242</b> 50.8 mm 2"</p>	 <p><b>LC-2261</b> 57.1 mm 2-1/4"</p>	 <p><b>LC-2275</b> 45.0 mm</p>
 <p><b>LC-2325</b> 30.1 mm 1-3/16"</p>	 <p><b>LC-2390</b> 48.0 mm 1-57/64"</p>	 <p><b>LC-2394</b> 60.3 mm 2-3/8"</p>	 <p><b>LC-2470</b> 60.3 mm 2-3/8"</p>



















**Lusac**



**Raybestos**  
The best in brakes

**REPUESTOS FRENO DE DISCO**

**LC-2472 - LC-2730**

 <p><b>LC-2472</b> 57.1 mm 2-1/4"</p>	 <p><b>LC-2473</b> 54.0 mm 2-1/8"</p>	 <p><b>LC-2475</b> 46.0 mm 1-13/16"</p>	 <p><b>LC-2476</b> 38.1 mm 1-1/2"</p>
 <p><b>LC-2477</b> 48.0 mm 1-57/64"</p>	 <p><b>LC-2478</b> 60.3 mm 2-3/8"</p>	 <p><b>LC-2479</b> 65.9 mm 2-19/32"</p>	 <p><b>LC-2484</b> 60.3 mm 2-3/8"</p>
 <p><b>LC-2486</b> 47.6 mm 1-7/8"</p>	 <p><b>LC-2489</b> 45.0 mm</p>	 <p><b>LC-2492</b> 44.0 mm</p>	 <p><b>LC-2493</b> 38.1 mm 1-1/2"</p>
 <p><b>LC-2496</b> 48.0 mm 1-57/64"</p>	 <p><b>LC-2500</b> 54.0 mm 2-1/8"</p>	 <p><b>LC-2725</b> 50.8 mm 2"</p>	 <p><b>LC-2730</b> 55.6 mm 2-3/16"</p>



**Lusac**



**Raybestos**  
The best in brakes

FOTOS REPUESTOS FRENO DE DISCO

## REPUESTOS FRENO DE DISCO

## LC-2735 - LC-2827

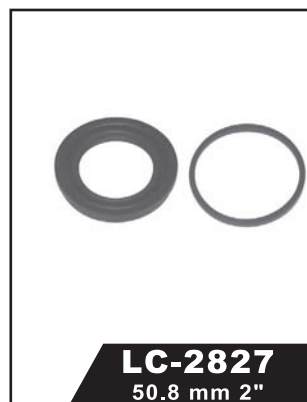
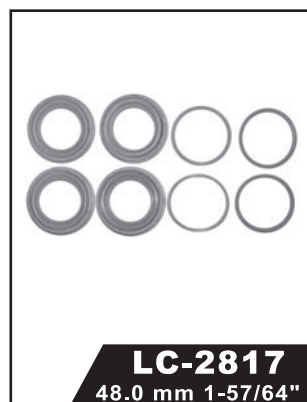
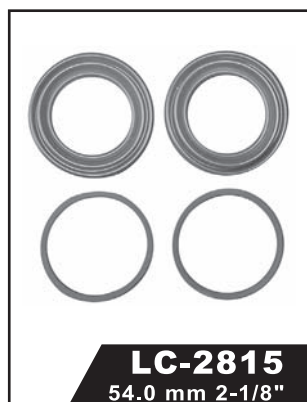
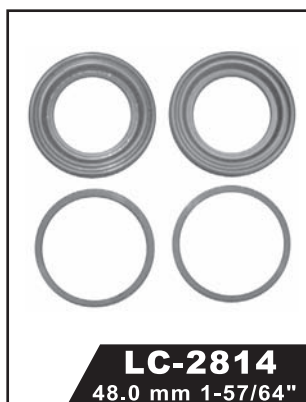
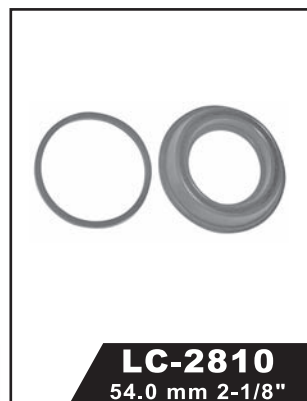
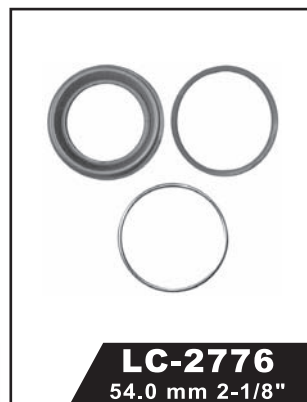



















**Lusac**



**Raybestos**  
The best in brakes

**REPUESTOS FRENO DE DISCO**

**LC-8844 - LC-21016**

 <p><b>LC-2844</b> 60.0 mm</p>	 <p><b>LC-2845</b> 54.0 mm 2-1/8"</p>	 <p><b>LC-2857</b> 46.0 mm 1-13/16"</p>	 <p><b>LC-2885</b> 55.9 mm 2-13/64"</p>
 <p><b>LC-2901</b> 48.0 mm 1-57/64"</p>	 <p><b>LC-20020</b> 42.0 mm</p>	 <p><b>LC-20460</b> 47.6 mm 1-7/8"</p>	 <p><b>LC-20930</b> 59.5 mm 2-11/32"</p>
 <p><b>LC-21003</b> 65.9 mm 2-19/32"</p>	 <p><b>LC-21004</b> 57.1 mm 2-1/4"</p>	 <p><b>LC-21005</b> 34.0 mm 1-11/32"</p>	 <p><b>LC-21010</b> 50.8 mm 2"</p>
 <p><b>LC-21013</b> 54.0 mm 2-1/8"</p>	 <p><b>LC-21014</b> 54.0 mm 2-1/8"</p>	 <p><b>LC-21015</b> 57.1 mm 2-1/4"</p>	 <p><b>LC-21016</b> 57.15 mm 2-1/4"</p>



**Lusac**









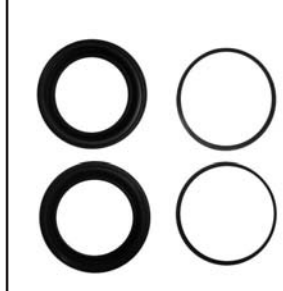

**Raybestos**  
The best in brakes

FOTOS REPUESTOS FRENO DE DISCO

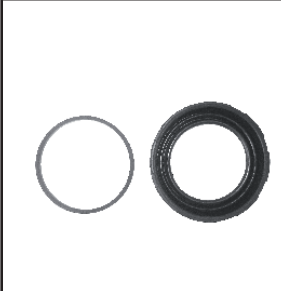
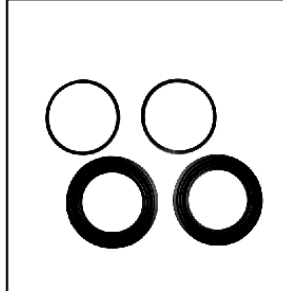
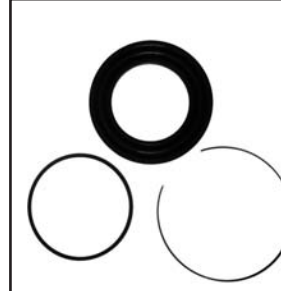
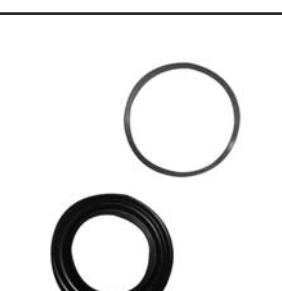
**REPUESTOS FRENO DE DISCO**

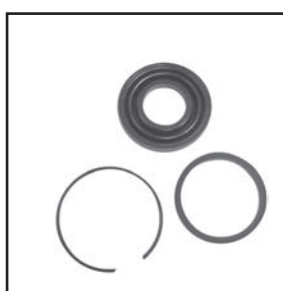
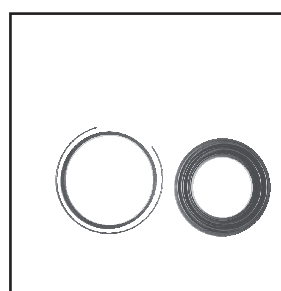
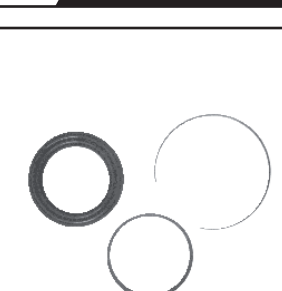
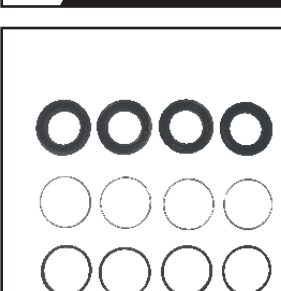
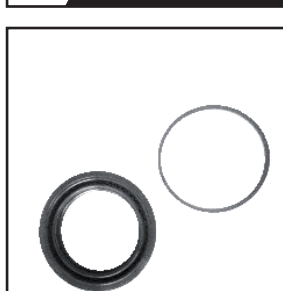
**LC-21019 - LC-21160**

 <p><b>LC-21019</b> 65.9 mm 2-19/32"</p>	 <p><b>LC-21020</b> 48.0 mm 1-57/64"</p>	 <p><b>LC-21023</b> 60.3 mm 2-3/8"</p>	 <p><b>LC-21041</b> 63.5 mm 2-1/2"</p>
 <p><b>LC-21042</b> 60.0mm</p>	 <p><b>LC-21047</b> 60.0 mm</p>	 <p><b>LC-21052</b> 45.5 mm</p>	 <p><b>LC-21051</b> 63.5 mm 2-1/2"</p>
 <p><b>LC-21067</b> 54.0 mm 2-1/8"</p>	 <p><b>LC-21068</b> 54.0 mm 2-1/8"</p>	 <p><b>LC-21069</b> 38.1 mm 1-1/2"</p>	 <p><b>LC-21072</b> 63.5 mm 2-1/2"</p>
 <p><b>LC-21075</b> 66.7 mm 2-5/8"</p>	 <p><b>LC-21076</b> 42.8 mm 1-11/16"</p>	 <p><b>LC-21080</b> 66 mm</p>	 <p><b>LC-21160</b> 64.0 mm</p>













**Lusac**



**Raybestos**  
The best in brakes

**REPUESTOS FRENO DE DISCO**

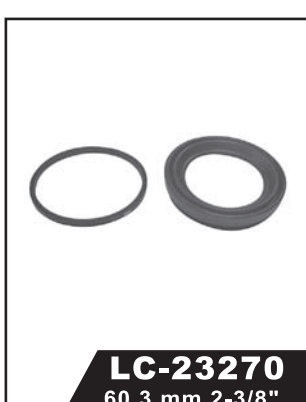
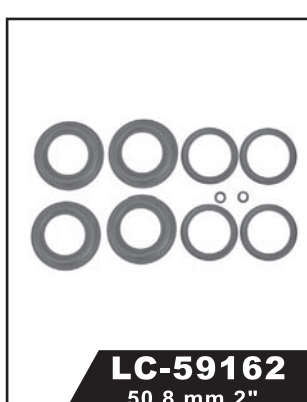
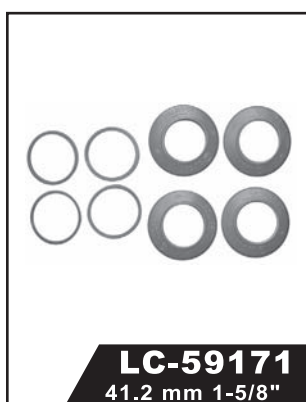
**LC-21310 - LC-76092**

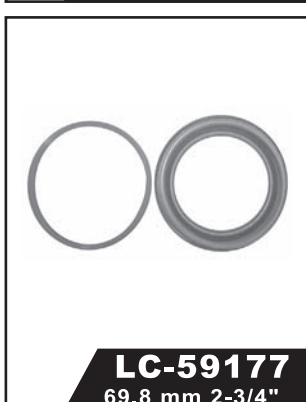
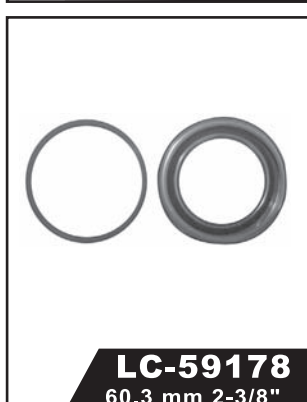
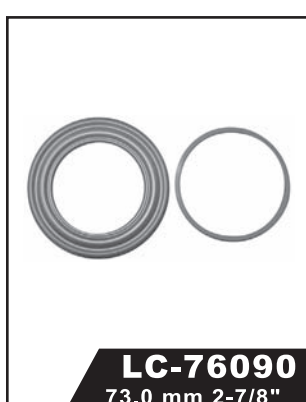
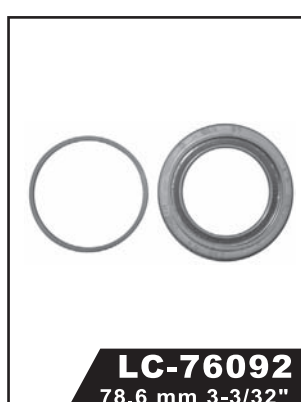
 <p><b>LC-21310</b> 33.7 mm</p>	 <p><b>LC-21330</b> 57.1 mm 2-1/4"</p>	 <p><b>LC-21341</b> 38.1 mm 1-1/2"</p>	 <p><b>LC-21470</b> 34.9 mm 1-3/8"</p>
 <p><b>LC-21640</b> 38.1 mm 1-1/2"</p>	 <p><b>LC-21995</b> 54.0 mm 2-1/8"</p>	 <p><b>LC-23220</b> 63.5 mm 2-1/2"</p>	 <p><b>LC-23260</b> 50.8 mm 2"</p>
 <p><b>LC-23270</b> 60.3 mm 2-3/8"</p>	 <p><b>LC-59162</b> 50.8 mm 2"</p>	 <p><b>LC-59171</b> 41.2 mm 1-5/8"</p>	 <p><b>LC-59176</b> 74.6 mm 2-15/16"</p>
 <p><b>LC-59177</b> 69.8 mm 2-3/4"</p>	 <p><b>LC-59178</b> 60.3 mm 2-3/8"</p>	 <p><b>LC-76090</b> 73.0 mm 2-7/8"</p>	 <p><b>LC-76092</b> 78.6 mm 3-3/32"</p>



**Lusac**







**Raybestos**  
The best in brakes

FOTOS REPUESTOS FRENO DE DISCO

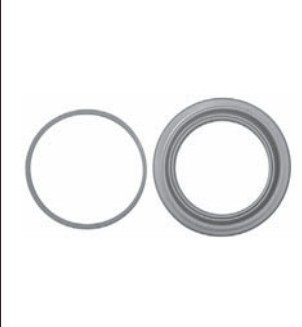
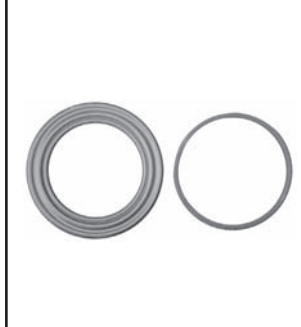
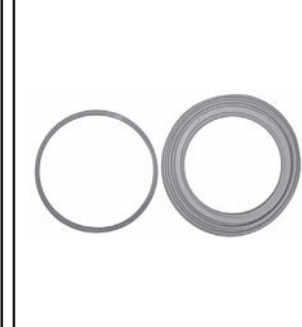
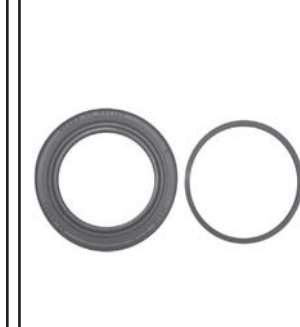
## REPUESTOS FRENO DE DISCO

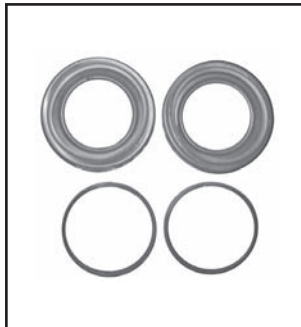
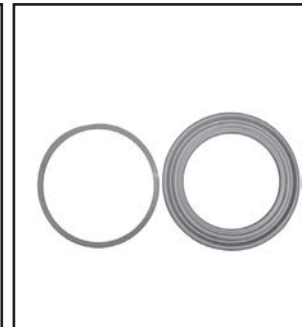
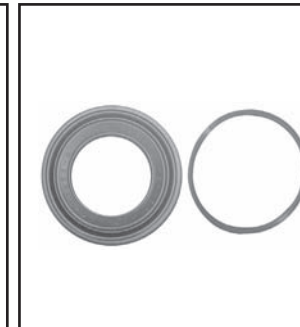
## LC-76390 - LC-118265

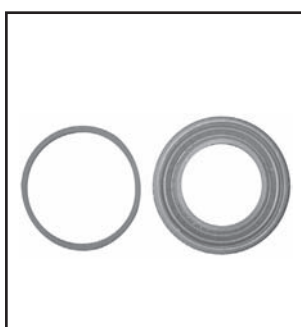
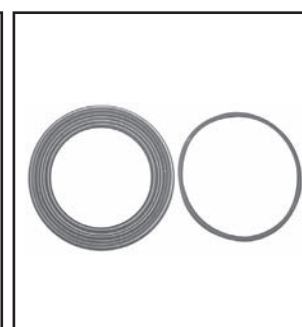
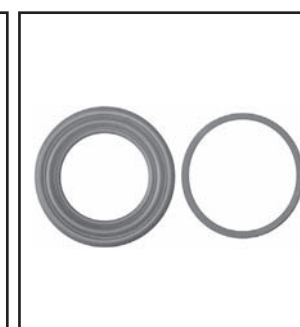
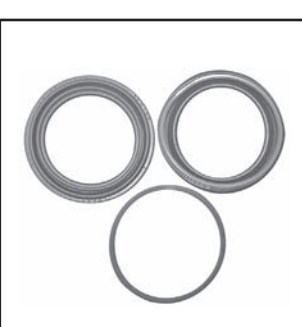
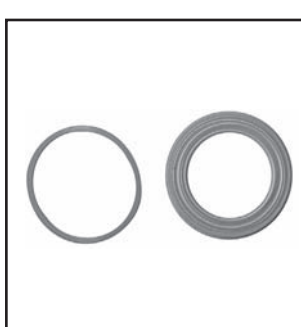
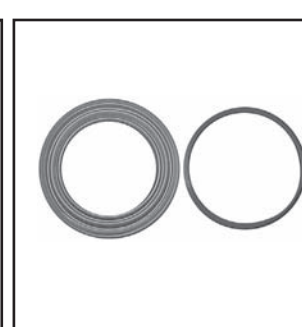
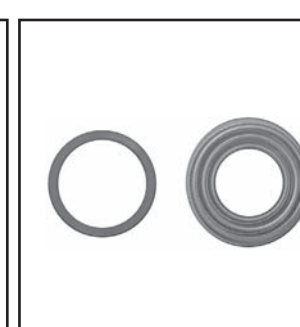
 <p><b>LC-76390</b> 78.6 mm 3-3/32"</p>	 <p><b>LC-80926</b> 79.4 mm 3-1/8"</p>	 <p><b>LC-83297</b> 85.7 mm 3-3/8"</p>	 <p><b>LC-83691</b> 65.9 mm 2-19/32"</p>
 <p><b>LC-88562S</b> 55.6 mm 2-3/16"</p>	 <p><b>LC-88562D</b> 55.6 mm 2-3/16"</p>	 <p><b>LC-98948</b> 73.0 mm 2-7/8"</p>	 <p><b>LC-99024</b> 63.5 mm 2-1/2"</p>
 <p><b>LC-99079</b> 60.0 mm</p>	 <p><b>LC-100797</b> 57.1 mm 2-1/4"</p>	 <p><b>LC-101491</b> 78.6 mm 3-3/32"</p>	 <p><b>LC-102443</b> 54.0 mm 2-1/8"</p>
 <p><b>LC-103299</b> 69.8 mm 2-3/4"</p>	 <p><b>LC-108241</b> 60.0 mm</p>	 <p><b>LC-112486</b> 65.9 mm 2-19/32"</p>	 <p><b>LC-118265</b> 34.1 mm 1-11/32"</p>